

# Operating instructions for safety control unit mod. NC88



## Description

The NC88 safety relay is created for use in safety circuit intended by EN 81-20:2014, EN 81-50:2014  
This module is based upon the use of guided-contact safety relays.

## ⚠ Safety Precautions ⚠

The manufacturer of a machine or installation is responsible for correct and safe overall function.

Auxiliary output Y1/Y2 and Y2/Y3 are optoisolated and gives informations about the state of the device; it must not be used as a safety output.  
**NC88 is not proper for the operation in presence of ionizing and not ionizing radiations (rays X, microwaves, laser, ultraviolet rays)**  
(CEI EN 60204-1:2006, §4.4.7).

## Functioning

The **NC88** Module can control the state of two Reed magnetic sensors : the output is activated by pressing the START button only if the contacts of two sensors are closed. The opening of even only one input contact (S1 and/or S2), leads to a safety situation, by putting the safety outputs in open state and by preventing the closing even after the re-closing of the contact and the pressure of the START button.

For automatic start, see connection diagram.

Input channels work on opposite potentials (S11 →-; S21 →+).

It's available an input (X1-X2) for feedback with contactors or external relays (see Ka and Kb on the connection diagram).

The control unit has a dedicated circuit to guarantee the its correct functionality in case of short voltage dips

The safety is ensured by using guided contacts, by the redundancy and by the interconnection schematic of the contacts.

The responsibility to choose the adequate components for safety applications, for example guided contacts safety relays, falls to the user.

## Assembly

Installation must be performed by authorized personnel only.

The NC88 control unit must be assembled in a suitable operating area (switch cabinet, protective housing).

The unit is installed by clipping it to a standard 35 mm top-hat rail.

## Connections

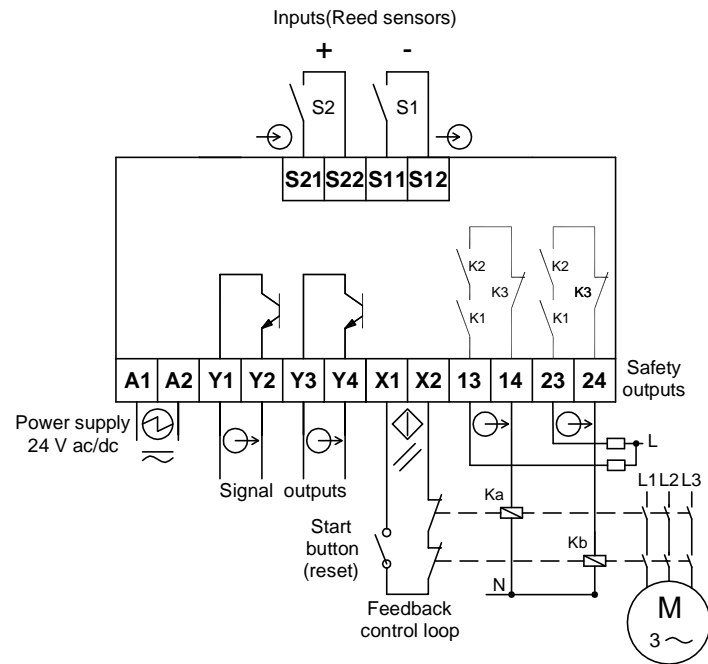

## Electrical Connection

Electrical connection must be performed by authorized personnel only.  
All the electrical inputs must either be isolated from the mains supply by a separate coils safety transformer in accordance with EN IEC 61558-2-6 with limited output voltage in the event of a defect or by another equivalent movable mechanism.

The outputs of the relays have a maximum current of 3 A; the supply connected to the outputs must be protected from overcurrents by devices adequate to the loads that have to be protected.

All the output contacts must have an adequate protective circuit for capacitive and inductive loads.

If a common power supply is used, all the inductive and capacitive loads (e.g. relay contactors) connected to the power supply must be connected to appropriate interference suppressors.

## Service and Inspection

The correct functioning of the NC88 safety unit must be controlled by the operator and/or by the control circuit of the elevator in which it is used periodically, by checking:

- Correct switching function of each sensor by checking:
  - a) that the opening of the single sensor will cause the opening of the safety outputs (13-14 / 23-24)
  - b) that the closure of the same sensor will cause the closing of the safety outputs (13-14 / 23-24) as a result of a startup command
- secure mounting of components
- correct connection fixing.

The monitoring function of the unit is done at every switching cycle. If the elevator is in a door zone and following the eventual start command, the safety device does not activate its safety outputs, **do not turn off and turn on the device**, then proceed to the checking of the possible sensor fault and perform the above tests in point a) and b).

In the event of damage or wear and tear, the damaged system component must be replaced.

## Liability coverage is void under the following circumstances:

- if instructions are not followed
- non-compliance with safety regulations
- installation and electrical connection not performed by authorized personnel
- non-implementation of functional checks.

## Setup

If the control unit does not appear to function when operating voltage is applied (yellow LED does not light up), the unit must be returned unopened to the manufacturer.

Check whether the safety outputs are being switched (see LED display) by activating the two inputs S1, S2 and START.

## Automatic start connections

- 1) Automatic start with the sync time between inputs infinite (ONLY for use in the lift industry - EN81-20: 2014).

Reed switch sensors ID, IS and IZ.

In this configuration the inputs synchronization time among the closing of IZ and one between IS and ID, it is endless, but a correct closing sequence has to be respected: the first contact to be closed is IZ, then IS or ID.

This configuration cannot be used with Hall effect sensors.

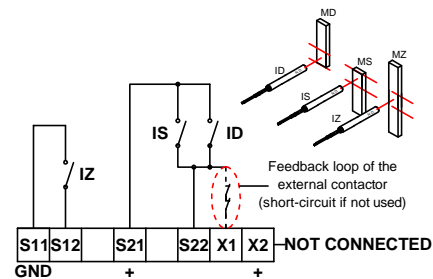

- 2) Short-circuit of S33 and S34; in this case there will be a synchronism time between inputs of 600 ms.

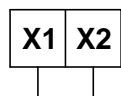

# Operating instructions for safety control unit mod. NC88



## Dimensions

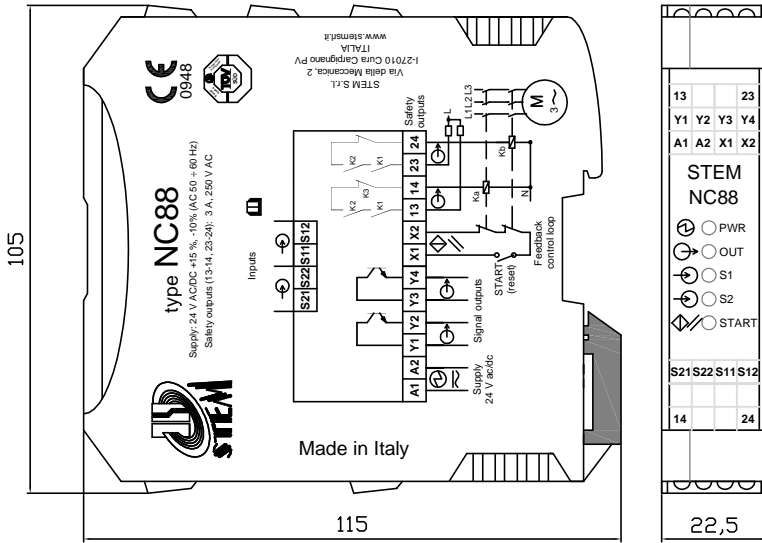

## LED DISPLAYS

Function	LED	Color (ON)	State
Supply Voltage	Power	green	on
Outputs 13/14, 23/24 and Y1/Y2: OPEN	OUT	-	off
Outputs 13/14, 23/24 and Y1/Y2: CLOSE	OUT	green	on
Inputs S1, S2, START: OPEN	S1, S2 START	-	off
Inputs S1, S2, START: CLOSE	S1, S2 START	green	on

## TECHNICAL DATA

Parameter	Value	Units
Housing Material	PA 6.6	
Dimensions / Weight	115 x 105 x 22,5 / 180	mm / g
Operating conditions	Temperature: 0 ... +55	°C
	Relative humidity: 4% ... 100%	
	Pressure: 86 ... 106	kPa
Housing conditions	Temperature: -25 ... +70	°C
	Relative humidity: 5% ... 95%	
	Pressure: 86 ... 106	kPa
Degree of protection (IEC 60529)	IP20	
Degree of contamination	3	
Overvoltage Category	III	
Assembly	DIN standard 35 mm guide	
Connection type	Plug-in screw terminals	
Supply voltage	24 +15%, - 10% (AC 50 ÷ 60 Hz)	V ac/dc
Internal fuse on the supply	750 mA resettable PTC	
Current consumption	OUT=off: 50 OUT=on: 100	mA
Max. switching frequency	1	Hz
Input synch. time ts (automatic start -2-)	600	ms
Output response time (t1)	Typical 120, max 160	ms
OFF state response time (t2)	15	ms
Safety outputs terminals	13-14 e 23-24 (normally open)	
Safety Output switching voltage	250	V AC
Safety output switching current	3 (MAX)	A
Safety output switching power	750	VA
Auxiliary outputs terminals	Y1-Y2, Y3-Y4 (collector-emitter optoinsulated)	
Auxiliary Output voltage	55 (MAX)	Vdc
Auxiliary output current	60 (MAX)	mA
Auxiliary output power	3,3	W
Usage category	AC-15: 0,9A, 250V	
Vibration resistance	EN 81-50:2014	
Electrical operation life	2,5 x 10 <sup>5</sup> (250 Vac, 3 A cosφ=1)	cycles
Mechanical operation life	10 <sup>7</sup>	cycles
EMC compliance	EN12015, EN12016, EN 61000-6-2, EN 61000-6-3, EN 55011:1999	
In accordance with	EN 81-20:2014, EN 81-50:2014	
Approvals	TÜV n° EDES 007	

## Timing diagram for manual start

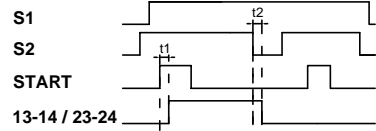

## Timing diagram automatic start - 1 -

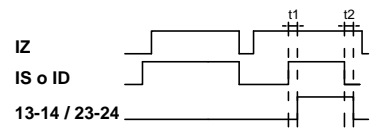

## Timing diagram automatic start - 2 - (X1-X2 bridged)

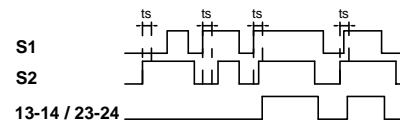

## Voltage dip

